

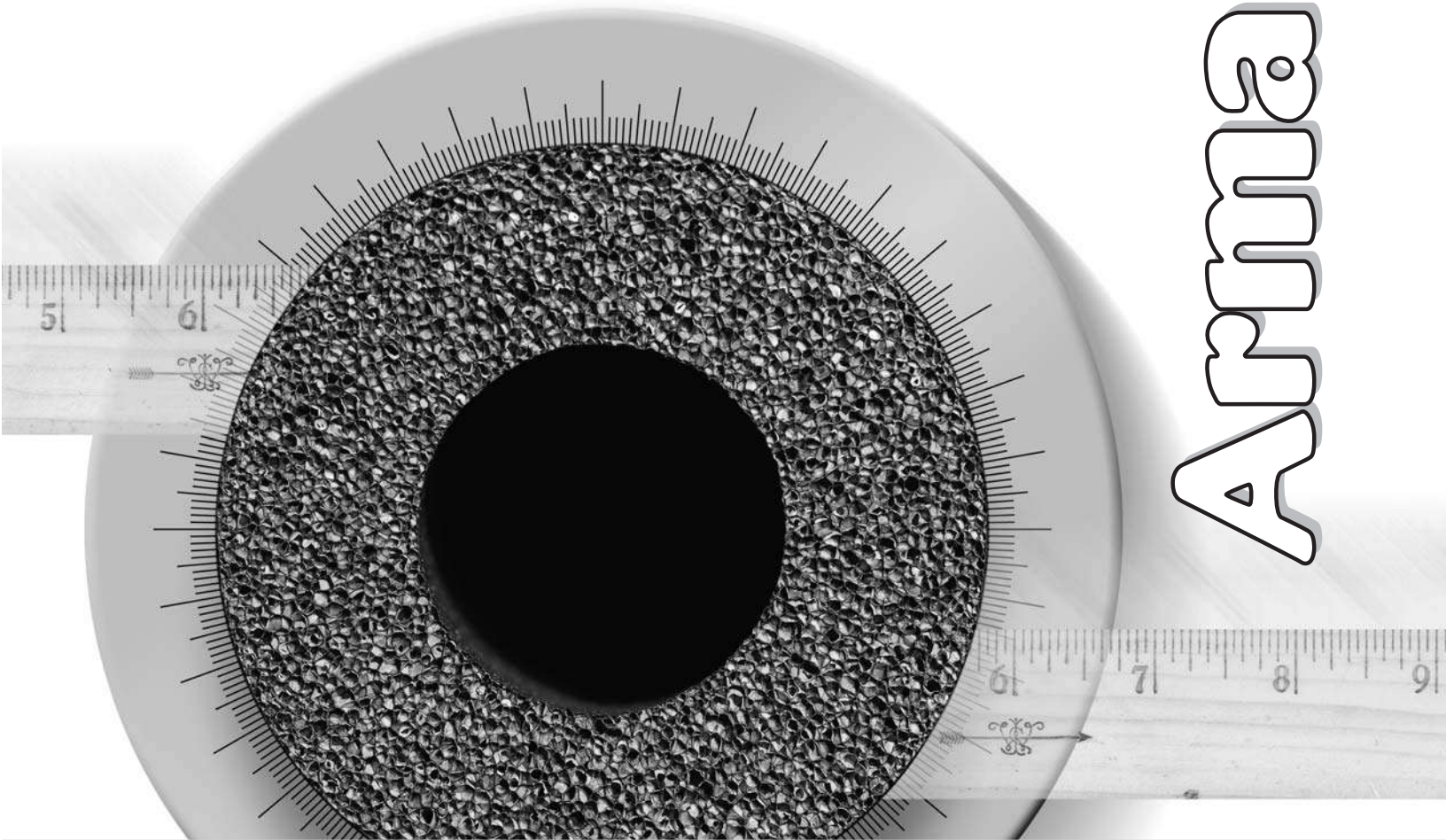

THE MAKERS OF
Armaflex®



Armaflex®



Installation Manual

Contents:

General information

- Armaflex Thickness Recommendations, p.2
- Rules for using Armaflex, p.3

Armaflex Tube Installation

- Sweat fittings on new pipe, p.4
- Screwed fittings on new pipe, p.4
- Armaflex on new piping: the slip-on method, p.5
- Armaflex on existing piping: the snap-on method, p.6
- Fabricating fitting covers, p.7
- Using miter boxes, p.8

Armaflex Sheet Installation & Templates

- Using Armaflex sheet insulation on pipes, p.9
- Application to fittings, p.9

- Template numbers and descriptions, p.11
- Armaflex sheet on 90° elbows, p.13
- Armaflex sheet on flanged valve fitting covers, p.14
- Armaflex sheet on metal ductwork, p.16
- ArmaTuff on exterior ductwork, p.17

Pipe Hangers

- Using Armaflex IPH or NPH at pipe hanger locations, p.18
- Traditional method for pipe hanger locations, p.18

Applying Self Sealing Armaflex

- AP Armaflex SS tube, p.19
- AP Armaflex SA sheet and roll, p.19

Armaflex Thickness Recommendations

For Controlling Outer Insulation Surface Sweating

(Based upon available manufactured thicknesses)

Armaflex Pipe Insulation Thickness Recommendations

For Controlling Outer Insulation Surface Condensation

(Based upon available manufactured thicknesses)

Pipe Size	Line Temperatures			
	50°F (10°C)	35°F (2°C)	0°F (-18°C)	-20°F (-29°C)
BASED ON NORMAL DESIGN CONDITIONS* 3/8" ID through 1-1/8" ID (10mm–28mm) Over 1-1/8" ID through 2-1/8" ID (28mm–54mm) Over 2-1/8" ID through 2-5/8" ID (54mm–65mm) Over 2-5/8" ID through 6" IPS (65mm–168mm)	Nom 3/8" (10mm) Nom 3/8" (10mm) Nom 3/8" (10mm) Nom 1/2" (13mm)	Nom 1/2" (13mm) Nom 1/2" (13mm) Nom 1/2" (13mm) Nom 3/4" (19mm)	Nom 3/4" (19mm) Nom 1" (25mm) Nom 1" (25mm) Nom 1" (25mm)	Nom 1" (25mm) Nom 1" (25mm) Nom 1-1/4" (32mm) Nom 1-1/4" (32mm)
BASED ON MILD DESIGN CONDITIONS** 3/8" ID through 2-5/8" ID (10mm–65mm) Over 2-5/8" ID through 6" IPS (65mm–168mm)	Nom 3/8" (10mm) Nom 1/2" (13mm)	Nom 3/8" (10mm) Nom 1/2" (13mm)	Nom 1/2" (13mm) Nom 1/2" (13mm)	Nom 3/4" (19mm) Nom 3/4" (19mm)
BASED ON SEVERE DESIGN CONDITIONS*** 3/4" ID through 1-5/8" ID (10mm–40mm) Over 1-5/8" ID through 3-5/8" ID (40mm–90mm) Over 3-5/8" ID through 6" IPS (90mm–168mm)	Nom 3/4" (19mm) Nom 3/4" (19mm) Nom 3/4" (19mm)	Nom 1" (25mm) Nom 1" (25mm) Nom 1" (25mm)	Nom 1-1/2" (38mm) Nom 1-1/2" (38mm) Nom 1-1/2" (38mm)	Nom 1-1/2" (38mm) Nom 1-3/4" (44mm) Nom 2" (50mm)

NOTE: Thicknesses greater than 1" (25mm) are multiple-layer applications.

*BASED ON **NORMAL DESIGN CONDITIONS** AP Armaflex in the thicknesses noted and within the specified temperature ranges will control outer insulation surface condensation indoors under **normal** design conditions, a maximum severity of **85°F (29°C) and 70% RH**. Armacell research and field experience indicate that indoor conditions anywhere in the United States seldom exceed this degree of severity.

BASED ON **MILD DESIGN CONDITIONS AP Armaflex in the thicknesses noted and within the specified temperature ranges will control outer insulation surface condensation indoors under **mild** design conditions, a maximum severity of **80°F (27°C) and 50% RH**. Typical of these conditions are most air-conditioned spaces and arid climates.

***BASED ON **SEVERE DESIGN CONDITIONS** AP Armaflex in the thicknesses noted and within the specified temperature ranges will control outer insulation surface condensation indoors under **severe** design conditions, a maximum severity of **90°F (32°C) and 80% RH**. Typical of these conditions are indoor areas in which excessive moisture is introduced or in poorly ventilated confined areas where the temperature may be depressed below ambient.

Armaflex Sheet/Roll Insulation Thickness Recommendations

For Controlling Outer Insulation Surface Condensation

	Ducts—Tanks—Vessels—Equipment Metal Surface Temperature		
	50°F (10°C)	35°F (2°C)	0°F (-18°C)
BASED ON NORMAL DESIGN CONDITIONS AP Armaflex in the thicknesses noted and within the specified temperature ranges will control outer insulation surface condensation indoors under normal design conditions, a maximum severity of 85°F (29°C) and 70% RH . Armacell research and field experience indicate that indoor conditions anywhere in the United States seldom exceed this degree of severity.	3/8" (10mm) Nom.	3/4" (19mm) Nom.	1-1/2" (38mm) Nom.
BASED ON MILD DESIGN CONDITIONS AP Armaflex in the thicknesses noted and within the specified temperature ranges will control outer insulation surface condensation indoors under mild design conditions, a maximum severity of 80°F (27°C) and 50% RH . Typical of these conditions are most air-conditioned spaces and arid climates.	1/8" (3mm) Nom.	1/4" (6mm) Nom.	1/2" (13mm) Nom.
BASED ON SEVERE DESIGN CONDITIONS AP Armaflex in the thicknesses noted and within the specified temperature ranges will control outer insulation surface condensation indoors under severe design conditions, a maximum severity of 90°F (32°C) and 80% RH . Typical of these conditions are indoor areas in which excessive moisture is introduced or in poorly ventilated confined areas where the temperature may be depressed below ambient.	1" (25mm) Nom.	1-1/2" (38mm) Nom.	2" (50mm) Nom.

Installation:

1. To the contractor ...

Armaflex Insulations are ideal for such mechanical systems as plumbing, hot-water heating, dual temperature piping, air conditioning, and refrigeration.

Armaflex Insulations are two-purpose materials. They control condensation drip from cold piping operating at temperatures down to -297°F when used in recommended thicknesses. They save heat on hot pipes operating at temperatures up to 220°F . AP Armaflex SS may be used on lines operating up to 180°F .

How well Armaflex does these jobs depends on how good a job you do of installing the insulation. By following the simple directions in this booklet, you can do a first-class Armaflex installation job every time.

Installation Instructions

Rule 1.

Apply Armaflex Insulations only when pipes are clean, dry and unheated.

Rule 2.

DO NOT COMPRESS Armaflex at joists, studs, columns, ducts, etc. This is important because any insulation loses some of its insulation value if it is compressed. On cold pipes, condensation may occur where the insulation is compressed.

Rule 3.

DO NOT CROWD Armaflex-covered pipes. Space piping to allow for free circulation of air. Air movement is an extra safeguard against condensation on cold pipes, especially in hot, humid weather.

Rule 4.

NEVER STRETCH ARMAFLEX. Always use the proper-size Armaflex for a particular size pipe. Do not stretch it over the pipe. Use pieces of Armaflex that are at least as long as the section of pipe to be insulated. Butt-end joints can be made without stretching the lengths of Armaflex, and there will be no straining of the surface and joints.

Rule 5.

Proper sealing of all pipe insulation is important to minimize heat loss and control condensation. On cold lines, open, pipe insulation joints may allow the formation of condensate drip or contributing to possible pipe or tubing corrosion. All Armaflex insulation joints must be sealed as shown in our insulation instructions.

Note: Armaflex insulation products must be installed according to this guide. Proper installation is required to assure Armaflex insulation performance.

Installation:

Please note: For installing self sealing AP Armaflex SS, refer to p.19.

Sweat fittings on new pipe

1. Before fitting is soldered, push the Armaflex back on the tubing, and hold in place with clamps applied to the tubing. To avoid damage to the insulation, tubing and fitting temperatures must not exceed the upper use limit of 220°F. Remove clamps after fitting has been soldered and has cooled. Note that sweat fittings are insulated with the same size Armaflex as used on the tubing.

Note: Apply clamps to tubing, not to Armaflex. Insulate heavy bronze fittings with fitting covers fabricated and applied as directed under screwed-type fittings below. The solvent in 520 and 520 BLV Adhesive is flammable, so take precautions during soldering. Always close the container tightly when not using; keep it away from heat or sparks. (Read the cautions on the label.)

2. Fabricate fitting cover from properly miter-cut pieces. After adhesive has dried, carefully

slit the fitting cover. See Section 4 on page 7, Fabricating Fitting Covers.

3. Snap fitting cover in place over the fitting.
4. After the line has been tested, apply brush coating of 520 or 520 BLV Adhesive to all joint surfaces.
5. Allow the adhesive to dry until dry to the touch but tacky under slight pressure before joining surfaces.

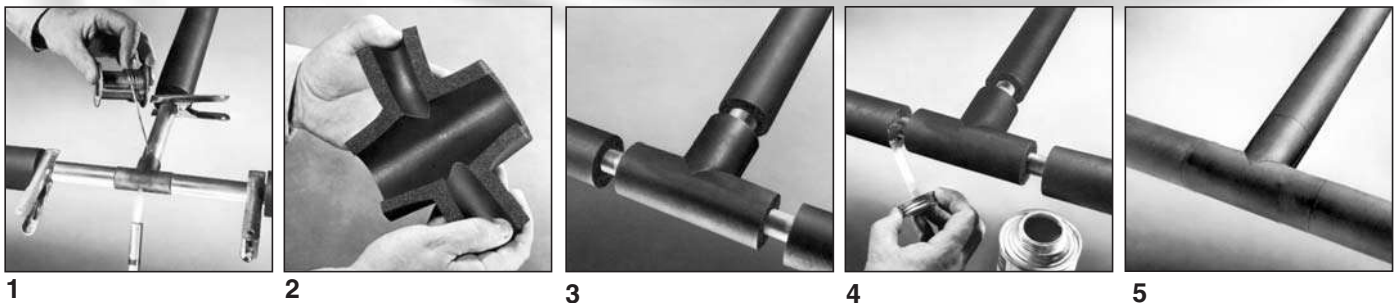

6. Armaflex is slipped over the line and butted tightly against the fitting.

7. Fabricate fitting covers from miter-cut pieces of Armaflex. Slit the completed cover, and snap it in position over the fitting. (Fitting cover should overlap the pipe insulation by at least one inch.)

8. After the line has been tested, complete the application by cementing the slit joint of the fitting cover with 520 or 520 BLV Adhesive. When adhesive has become tacky to the touch, press the joint firmly together. Also, cement the 1" overlap with 520 or 520 BLV Adhesive by forcing the brush between the two surfaces.

Screwed fittings on new pipe

Insulate screwed fittings with sleeve-type fitting covers made up from Armaflex Pipe Insulation having an inside diameter large enough to overlap the insulation on the straight piping next to the fitting by at least 1". See chart on page 8 for sleeving sizes.



6



7

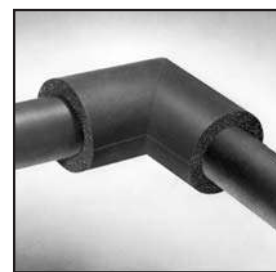

8

Please note: For installing self sealing AP Armaflex SS, refer to p.19.

Installation:

2. Armaflex on new piping: the slip-on method

The slip-on method is used when you can insulate new piping before it goes up or while it's being connected.

1. All you do is slip the pipe insulation over the pipe or copper tubing. The inside surface of Armaflex Pipe Insulation is coated with a powdered lubricant, making it easy to slip the insulation over the pipe.

(note: Small amounts of powdered lubricant may enter open ends of pipe or tubing. This dust must be kept out of refrigeration systems. Plug open ends of pipe before slipping on Armaflex Pipe Insulation.)

2. Since Armaflex tubing is flexible, it will follow bends in tubing and can be slipped right over bent tubing, 45° sweat ells, and couplings.

3. At 90° sweat ells, cut the insulation, and butt against each side of the fitting. A fitting cover will be installed later over these fittings. See Section 4 on page 7, Fabricating Fitting Covers.

4. Use a length of Armaflex as long as or slightly longer than the section of piping to be covered. **NEVER STRETCH ARMAFLEX.**

5. Apply brush coating of 520 or 520 BLV Adhesive to both butt ends to be joined, since this is a contact-type adhesive.

6. Allow the adhesive to set until dry to the touch but tacky under slight pressure before joining surfaces.

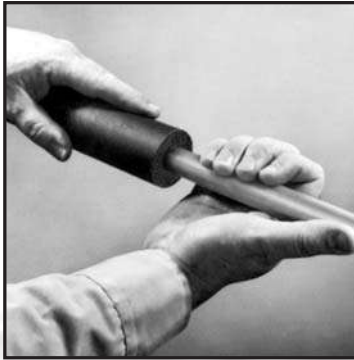

1



2



3



4



5



6

Installation:

Please note: For installing self sealing AP Armaflex SS, refer to p.19.

3. Armaflex on existing piping: the snap-on method

The snap-on method is used when pipe or copper tubing is insulated after it has been installed and connected.

Armaflex pipe insulation

1. With unslit tubular Armaflex Pipe Insulation, use a sharp knife to slit the Armaflex lengthwise on one side. For oval tubes, slit on flat side only.
 2. Snap the insulation over the pipe.
 3. Brush-coat both slit surfaces with Armaflex 520 or 520 BLV Adhesive alternating sides for even drying time. Push the insulation down over pipe to hold adhesive-coated surfaces apart while the adhesive dries.
 4. Allow the adhesive to dry until dry to the touch but tacky under slight pressure before joining surfaces. Test with back of fingernails as shown.
- 520 or 520 BLV Adhesive bonds instantly on contact, so pieces must be put together accurately. Press joints together firmly, making sure that you get a bond all the way through the joint, not just at the outer edges.
5. If the insulation should become stuck to the pipe after applying adhesive, break the insulation loose by running a finger down the pipe as shown in the illustration.

6. When the adhesive has air-dried, apply moderate pressure to entire joint to assure a vapor-tight bond.
7. In double-layer work when using the snap-on method, apply Armaflex with side and end joints staggered where possible.

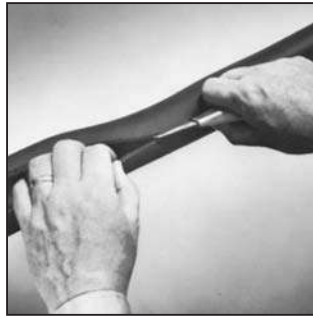

When hot-water piping is being insulated, allow a minimum of 36 hours before circulating hot water into insulated lines having adhesive-bonded slit seams.

Before using 520 or 520 BLV Adhesive, read the precautionary information printed on the can label. (Also see "520 or 520 BLV Adhesive" submittal sheet)



Installation:

4. Fabricating fitting covers

This section includes:

- a. Using miter boxes, pg 8
- b. Using Armaflex Sheet on pipes, pgs 9 & 10
 - b.1. Armaflex Templates, pg 11
 - b.2. Yield of Armaflex Sheet, pgs 11-12
- c. Armaflex Sheet on 90° Elbows, pg 13
- d. Armaflex Sheet on Flanged Valve Fitting Covers, pgs 14-15

Use unsplit Armaflex when making up covers for fittings. Make up a group of covers at one time instead of cutting and assembling each one as you come to it.

Sweat and screwed fittings

On sweat fittings, use the same size Armaflex for covers that you use to insulate the tubing.

On screwed fittings, make up fitting covers from Armaflex with an inside diameter large enough to overlap the insulation on the pipe next to the fitting. Make the fitting cover long enough to overlap pipe insulation by a minimum of one inch on each side. (See sleeving sizes on page 8.)

Large-size pipes

On large-size weld pipes (3" IPS and above) and screwed iron pipes (2", 2-1/2" and 3"), fitting covers can be made from Armaflex Sheet Insulation. Armaflex Sheet is available in 36" x 48" sheets or 4'-wide rolls in a variety of thicknesses and lengths. Fitting covers for

Victaulic Couplings can also be made from Armaflex Sheet Insulation. Sheets can be cut easily and accurately, using a sharp knife and a template. (See page 11 for template size and pattern number.)

Tight joints mean a trouble-free job

Important: Use Armaflex 520 or 520 BLV Adhesive only.

Armaflex 520 or 520 BLV Adhesives are vapor-retarder adhesives developed for use with Armaflex Insulations. Use it properly, and you'll have joints that stay tight.

Tools for making fitting covers

1. Miter Box: A sturdy miter box and a knife can do most large-size pipe fittings up to 5" IPS. The miter box can also be used on smaller-size pipe fittings.
2. Sheet Templates
For screwed iron pipe fittings 2", 2-1/2" and 3" IPS and for long-radius weld iron pipe fittings 3" IPS to 10" IPS, use Armaflex Sheet Templates. These sheet templates take all the guesswork out of insulating 45° ell, 90° ell, and tee fittings. Available from Armacell, each template set comes with complete application instructions. (See pages 11-12 for details.)
3. Armaflex Sheet Templates are also available to make fitting covers for Victaulic Couplings. The fitting cover templates are available for pipe sizes from 3/4" IPS to 12" IPS.

4. Use carton template on the side of all 6' tube cartons, to make fitting covers for 45, 90, ells, tees.

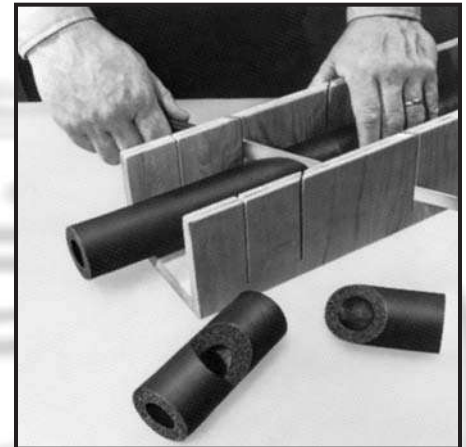

1

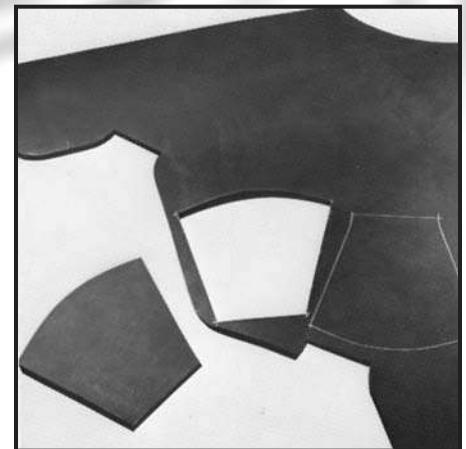

2

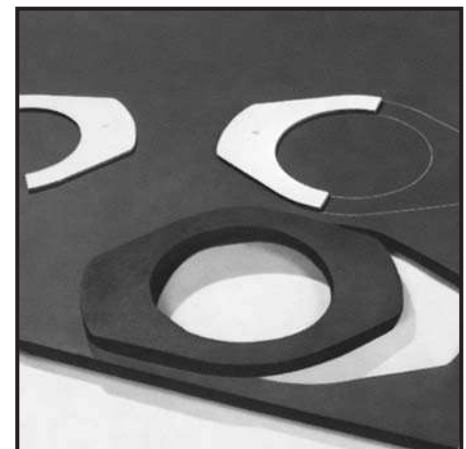

3

Installation:

4.a. Using miter boxes

1. Use a sharp, non-serrated edge knife. Note the long knife length shown in photo.
2. On smaller pieces of Armaflex Pipe Insulation, brace the piece to be cut with your hand as illustrated. This will insure a clean and accurate cut.
3. The illustrations show sleeve-type fitting covers. The same fabrication steps may be used for copper tube fittings.

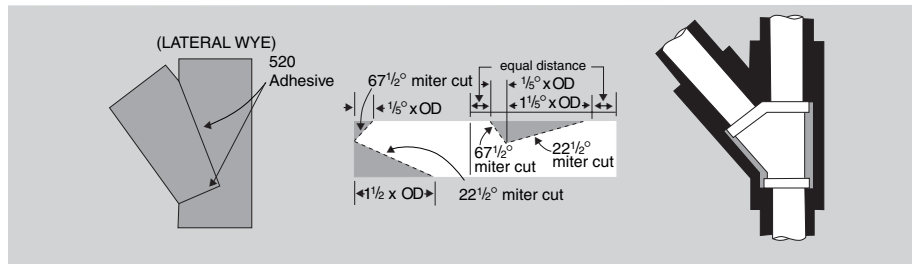
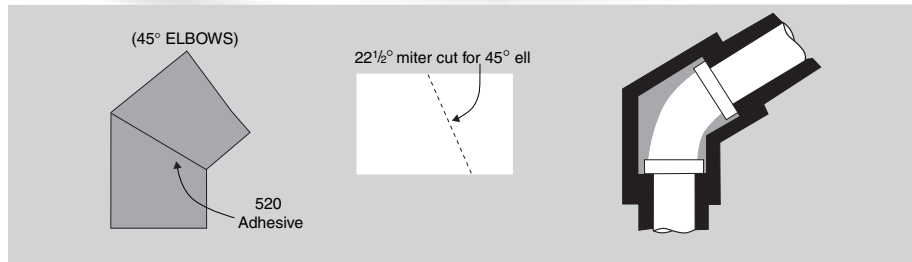
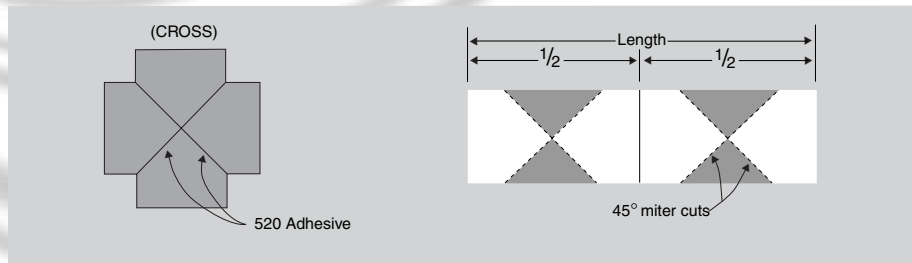
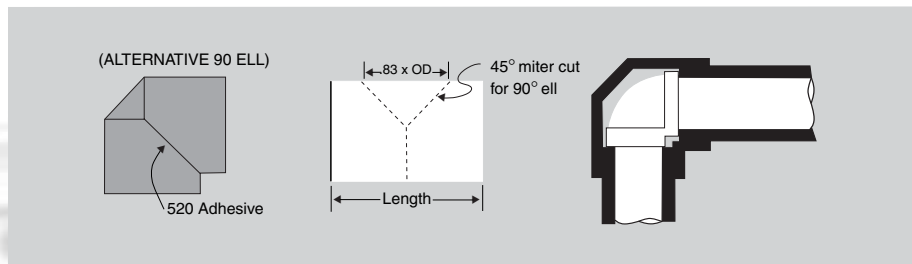
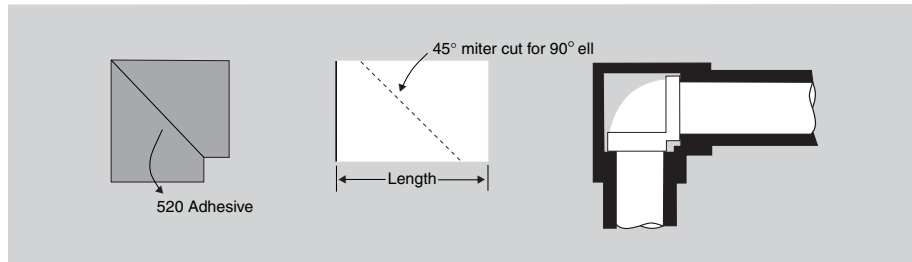
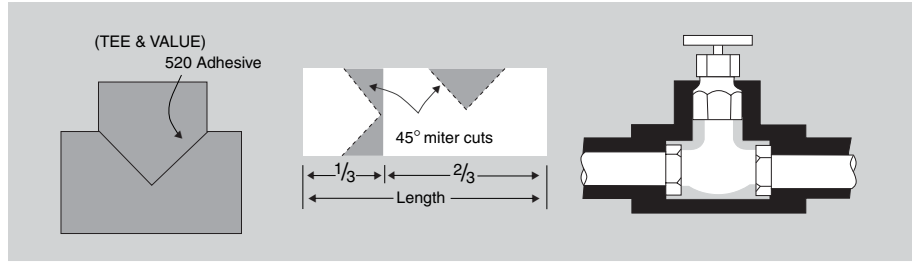
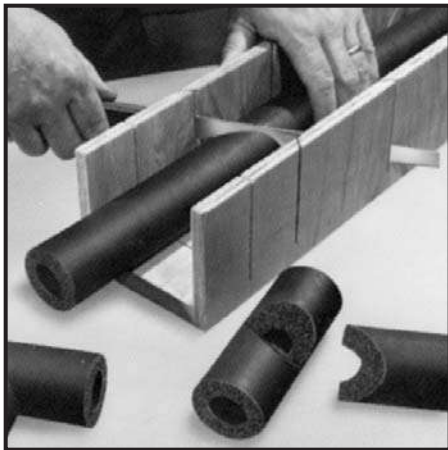

ARMAFLEX SLEEVING SIZES						
Armaflex Insulation Sizes (in.)	Copper Tubing		Nom Iron Pipe Size (in.)	Sleeving Sizes†		
	Nom Size (in.)	OD Size (in.)		Nom 3/8" Wall (in.)	Nom 1/2" Wall (in.)	Nom 3/4" Wall (in.)
3/8 ID	1/4	3/8	—	1-1/8 ID	1-3/8 ID	1-5/8 ID
1/2 ID	3/8	1/2	1/4	1-3/8 ID	1-3/8 ID	1-1/2 IPS
5/8 ID	1/2	5/8	3/8	1-3/8 ID	1-5/8 ID	2-1/8 ID
3/4 ID	5/8	3/4	—	1-5/8 ID	1-1/2 IPS	2 IPS
7/8 ID	3/4	7/8	1/2	1-5/8 ID	1-1/2 IPS	2 IPS
3/4 IPS	—	—	3/4	1-1/2 IPS	2-1/8 ID	2-1/2 IPS
1-1/8 ID	1	1-1/8	—	1-1/2 IPS	2-1/8 ID	2-1/2 IPS
1-3/8 ID	1-1/4	1-3/8	1	2-1/8 ID	2 IPS	3-1/8 ID
1-5/8 ID	1-1/2	1-5/8	1-1/4	2 IPS	2-1/2 IPS	3-5/8 ID
1-1/2 IPS	—	—	1-1/2	2-1/2 IPS*	3-1/8 ID	3-5/8 ID
2-1/8 ID	2	2-1/8	—	2-1/2 IPS*	3-5/8 ID*	4-1/8 ID*
2 IPS	—	—	2	3-5/8 ID*	3-5/8 ID	4-1/8 ID
2-5/8 ID	2-1/2	2-5/8	—	3-5/8 ID*	4-1/8 ID*	4 IPS*
2-1/2 IPS	—	—	2-1/2	—	4-1/8 ID	4 IPS
3-1/8 ID	3	3-1/8	—	—	4 IPS*	5 IPS*
3-5/8 ID	3-1/2	3-5/8	3	—	5 IPS*	5 IPS*
4-1/8 ID	4	4-1/8	3-1/2	—	5 IPS*	Sheet
4 IPS	—	—	4	—	Sheet	Sheet

†Based on average wall thicknesses developed from factory tolerances.
 *May require cutting.
 *Available Nom 1/2" or Nom 3/4" thickness only.

Please note: For installing self adhering SA Armaflex sheets and rolls, refer to p.19.

Installation:

4.b. Using Armaflex sheet insulation on pipes

Application to pipes

1. Apply Armaflex Sheet
Insulation on pipes larger than 5" IPS. Cut the sheet insulation to proper width, permitting it to fit loosely without stretching around the pipe. (See pgs 11-12.) The fabrication must be done at the job site, at the same ambient conditions as the application.
2. Brush-coat both surfaces of the lengthwise seam with 520 or 520 BLV Adhesive. Allow the adhesive to dry until tacky to the touch under slight pressure before joining surfaces. Wrap the sheet around the pipe, and seal the seam by pressing the surfaces firmly together. Join butt joints between individual sections using 520 or 520 BLV Adhesive. On horizontal pipes larger than 12" IPS, adhere insulation on lower one-third.

ting cover, the complete fitting cover is formed by adhering two halves together at the long outer arc. Coat both surfaces with 520 or 520 BLV Adhesive. Allow the adhesive to dry until dry to the touch but tacky under slight pressure before joining surfaces. Then seal the seam by pressing the surfaces firmly together throughout. To do

this, press the adhesive joint on the rough side and then snap the cover inside out and press the joint on the smooth skin side. (The tee template is a symmetrical half, but, in this case, both halves are laid out together to form the complete outline of the fitting cover.)



1

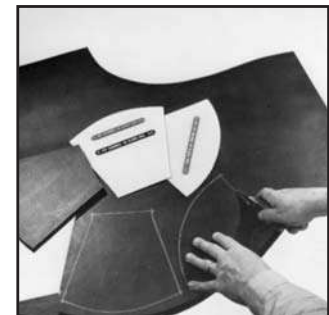

3



2

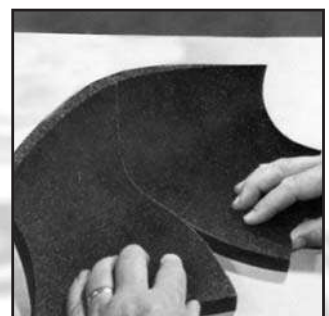

4

Application to fittings

3. Fitting covers are easily made, using templates designed specially for screwed fittings 2", 2-1/2" and 3" and long-radius weld fittings from 3" to 10" IPS. (See size chart, pg 11.)

Note: Templates should be traced on stiff paper, sheet metal or hardboard and cut out to make reusable patterns.

4. Since each template for 45° and 90° ells is shown as a symmetrical half of the full fit-

Installation:

Please note: For installing self adhering SA Armaflex sheets and rolls, refer to p.19.

5. Snap the formed cover in place over the fitting. Adhere the mating surfaces of the inner arc joint with 520 or 520 BLV Adhesive. Join the straight pipe covering to the fitting cover, making sure to coat both the pipe-section butt surface and the fitting-cover butt surface.



5



6

Note: On screwed fittings, select the proper template from section 4.b.1., page 11. Notice that the screwed fitting cover templates allow for the 1" minimum overlap on the straight pipe next to the fitting. Remember to cement this 1" overlap with 520 or 520 BLV Adhesive by forcing the brush between the two surfaces.

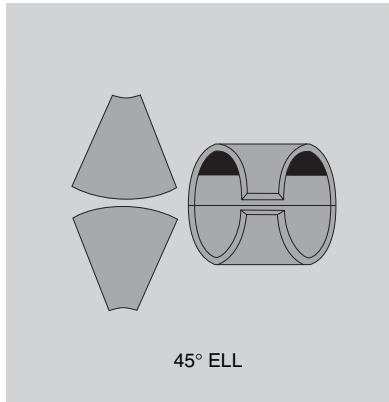

45° ELL

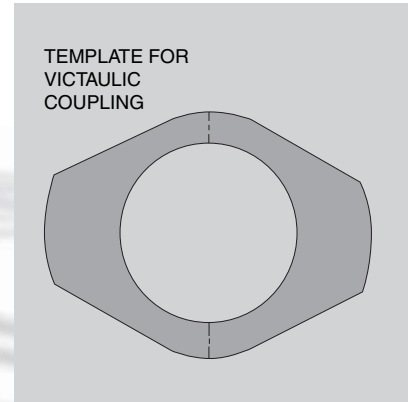

TEMPLATE FOR VICTAULIC COUPLING

6. Allow the adhesive to dry until dry to the touch but tacky under slight pressure before joining surfaces. Press surfaces firmly together to seal.

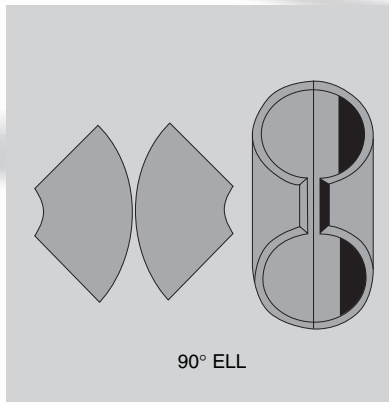

90° ELL

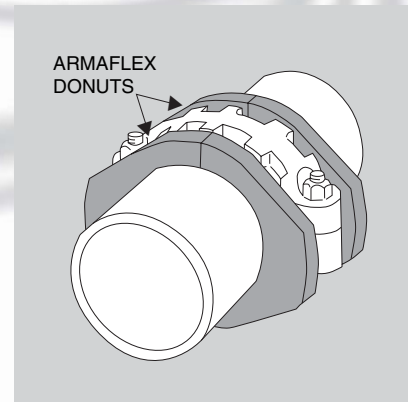

ARMAFLEX DONUTS

Application to Victaulic Couplings

Make two donuts, and place on both sides of the Victaulic Coupling. Complete the fitting cover by gluing the circumferential strip of sheet insulation over the two donuts.

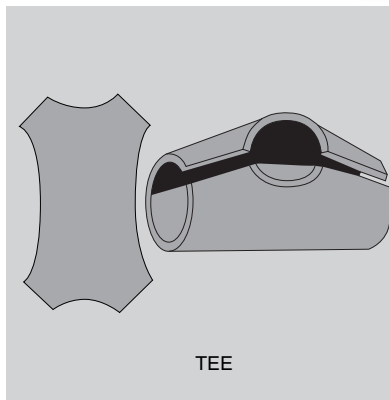

TEE

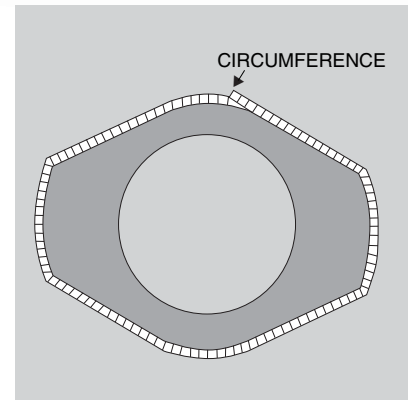

CIRCUMFERENCE

Installation:

4.b.1 Templates are available for screwed and long-radius weld fittings

Templates for the Iron Pipe Sizes Shown Below in 3/8", 1/2" and 3/4" Armaflex:

SCREWED						
Pipe Size	3/8"		1/2"		3/4"	
IPS	45°	90° T	45°	90° T	45°	90° T
2"	•	•	•	•	•	•
2-1/2"			•	•	•	•
3"			•	•	•	•

WELD								
Pipe Size	3/8"		1/2"		3/4"		1"	
IPS	45°	90° T	45°	90° T	45°	90° T	45°	90° T
3"			•	•	•	•	•	•
3-1/2"			•	•	•	•	•	•
4"			•	•	•	•	•	•
5"			•	•	•	•	•	•
6"			•	•	•	•	•	•
8"			•	•	•	•	•	•
10"			•	•	•	•	•	•

VICTAULIC COUPLINGS				
Pipe Size	3/8"	1/2"	3/4"	1"
3/4"	•	•	•	
1"	•	•	•	
1-1/4"	•	•	•	
1-1/2"	•	•	•	
2"	•	•	•	
2-1/2"	•	•	•	
3"		•	•	•
3-1/2"		•	•	•
4"		•	•	•
5"		•	•	•
6"		•	•	•
8"		•	•	•
10"		•	•	•
12"		•	•	•

There are twelve template sheets—order from Armacell. Templates for Victaulic Couplings and standard grooved end fittings are also available.

Template number and description

No. AT Set A
Screwed 45° Elbows
■ 3/8"—1/2"—3/4" Walls
■ 2", 2-1/2", 3" IPS

No. AT Set B
Screwed 90° Elbows
■ 3/8"—1/2"—3/4" Walls
■ 2", 2-1/2", 3" IPS

No. AT Set C
Screwed Tees
■ 3/8"—1/2"—3/4" Walls
■ 2", 2-1/2", 3" IPS

No. AT Set D
Weld 45° Long-Radius Elbows
■ 1/2" Wall
■ 3" IPS thru 10" IPS

No. AT Set E
Weld 45° Long-Radius Elbows
■ 3/4" Wall
■ 3" IPS thru 10" IPS

No. AT Set F
Weld 90° Long-Radius Elbows
■ 1/2" Wall
■ 3" IPS thru 10" IPS

No. AT Set G
Weld 90° Long-Radius Elbows
■ 3/4" Wall
■ 3" IPS thru 10" IPS

No. AT Set H
Weld Tees
■ 1/2" Wall
■ 3" IPS thru 10" IPS

No. AT Set I
Weld Tees
■ 3/4" Wall
■ 3" IPS thru 10" IPS

No. AT Set J
Weld Tees
■ 1" Wall
■ 3" IPS thru 10" IPS

No. AT Set K
Weld 45° Long-Radius Elbows
■ 1" Wall
■ 3" IPS thru 10" IPS

No. AT Set L
Weld 90° Long-Radius Elbows
■ 1" Wall
■ 3" IPS thru 10" IPS

4.b.2. yields of ...

... AP ARMAFLEX SHEET AS PIPE INSULATION

Pipe Size	Insulation Thickness	Insulation Width " (Pipe Circum.)	Sheet Length	LF Sheet	Drop-Off
3"	1/2	13-1/2	36	9	7-1/2
	3/4	14-5/8	36	9	4-1/8
	1	15-5/8	36	9	1-1/8
3-1/2"	1/2	15-1/8	36	9	2-5/8
	3/4	16-1/8	48	8	3-3/4
	1	17-1/8	48	8	1-3/4
4"	1/2	16-5/8	48	8	2-3/4
	3/4	17-3/4	48	8	1/2
	1	18-3/4	36	6	10-1/2
5"	1/2	20	36	6	8
	3/4	21-1/8	36	6	5-3/4
	1	22-1/8	36	6	3-3/4
	1-1/2	25-3/8	48	4	10-5/8
6"	1/2	23-3/8	36	6	1-1/4
	3/4	24-1/2	48	4	11-1/2
	1	25-3/8	48	4	10-5/8
	1-1/2	28-1/2	48	4	7-1/2
8"	1/2	29-5/8	48	4	6-3/8
	3/4	30-3/4	48	4	5-1/4
	1	31-3/4	48	4	4-1/4
	1-1/2	34-7/8	48	4	1-1/8
10"	1/2	36-1/4	36	3	11-3/4
	3/4	37-3/8	36	3	10-5/8
	1	38-3/8	36	3	9-5/8
	1-1/2	41-1/2	36	3	6-1/2
12"	1/2	42-5/8	36	3	5-3/8
	3/4	43-5/8	36	3	4-3/8
	1	44-5/8	36	3	3-3/8
14"	1/2	46-1/2	36	3	1-1/2
	3/4	47-5/8	36	3	3/8

For jobsite application sizing. Not intended for shop prefabrication.
Yield of Armaflex Sheet (36" x 48") when used on various pipe sizes.
All dimensions are in inches.

Installation:

Yields of ...

4.c. measuring ...

... 48-INCH-WIDE AP ARMAFLEX ROLLS AS PIPE INSULATION

... AP ARMAFLEX SHEET FOR WELDED 90° ELBOW FITTINGS

PIPE SIZE	INSULATION THICKNESS (In.)	INSULATION LENGTH (Pipe Circum., In.)	APPROX. ROLL LENGTH (LF)	PCS./ROLL (4-Ft. Lengths)	LF/ROLL (Ft.)
3" IPS	1/2	13-1/2	70	62	248
	3/4	14-5/8	50	41	164
	1	15-5/8	35	26	104
3-1/2" IPS	1/2	15-1/8	70	55	220
	3/4	16-1/8	50	37	148
	1	17-1/8	35	24	96
4" IPS	1/2	16-5/8	70	50	200
	3/4	17-3/4	50	33	132
	1	18-3/4	35	22	88
5" IPS	1/2	20	70	42	168
	3/4	21-1/8	50	28	112
	1	22-1/8	35	18	72
	1-1/2	25-3/8	25	11	44
6" IPS	1/2	23-3/8	70	35	140
	3/4	24-1/2	50	24	96
	1	25-3/8	35	16	64
	1-1/2	28-1/2	25	10	40
8" IPS	1/2	29-5/8	70	28	112
	3/4	30-3/4	50	19	76
	1	31-3/4	35	13	52
	1-1/2	34-7/8	25	8	32
10" IPS	1/2	36-1/4	70	23	92
	3/4	37-3/8	50	16	64
	1	38-3/8	35	10	40
	1-1/2	41-1/2	25	7	28
12" IPS	1/2	42-5/8	70	19	76
	3/4	43-5/8	50	13	52
	1	44-5/8	35	9	36
	1-1/2	47-3/4	25	6	24
14" IPS	1/2	46-1/2	70	18	72
	3/4	47-5/8	50	12	48
	1	48-1/2	35	8	32
	1-1/2	51-3/4	25	5	20
16" IPS	1/2	52-3/4	70	15	60
	3/4	53-3/4	50	11	44
	1	54-3/4	35	7	28
	1-1/2	58	25	5	20
18" IPS	1/2	59-1/8	70	14	56
	3/4	60	50	10	40
	1	61	35	6	24
	1-1/2	64-1/4	25	4	16
20" IPS	1/2	65-3/8	70	12	48
	3/4	66-3/8	50	9	36
	1	67-3/8	35	6	24
	1-1/2	70-1/2	25	4	16
24" IPS	1/2	77-7/8	70	10	40
	3/4	78-7/8	50	7	28
	1	79-7/8	35	5	20
	1-1/2	83-1/8	25	3	12

Pipe Size OD "	Pipe OD "	Sheet Thickness	Throat Meas.		Half Circumference Plus Throat Meas.	
			R ₁		R ₂	
			Short Radius	Long Radius	Short Radius	Long Radius
3	3-1/2	1/2	1-1/4	2-3/4	8	9-1/2
	3-1/2	3/4	1-1/4	2-3/4	8-1/2	10
	3-1/2	1	1-1/4	2-3/4	9	10-1/2
3-1/2	4	1/2	1-1/2	3-1/4	9	10-3/4
	3-1/2	3/4	1-1/2	3-1/4	9-1/2	11-1/4
	3-1/2	1	1-1/2	3-1/4	10	11-3/4
4	4-1/2	1/2	1-3/4	3-3/4	10-1/8	12-1/8
	4-1/2	3/4	1-3/4	3-3/4	10-5/8	12-5/8
	4-1/2	1	1-3/4	3-3/4	11-1/8	13-1/8
5	5-9/16	1/2	2-1/4	4-3/4	12-1/4	14-3/4
	5-9/16	3/4	2-1/4	4-3/4	12-3/4	15-1/4
	5-9/16	1	2-1/4	4-3/4	13-1/4	15-3/4
6	6-5/8	1/2	2-3/4	5-5/8	14-1/2	17-1/4
	6-5/8	3/4	2-3/4	5-5/8	15	17-3/4
	6-5/8	1	2-3/4	5-5/8	15-1/2	18-1/4
8	8-5/8	1/2	3-3/4	7-5/8	18-1/2	22-3/8
	8-5/8	3/4	3-3/4	7-5/8	19	23
	8-5/8	1	3-3/4	7-5/8	19-1/2	23-3/8
10	10-3/4	1/2	4-5/8	9-5/8	22-3/4	27-3/4
	10-3/4	3/4	4-5/8	9-5/8	23-1/4	28-1/4
	10-3/4	1	4-5/8	9-5/8	23-3/4	28-3/4
12	12-3/4	1/2	5-5/8	11-5/8	26-7/8	32-7/8
	12-3/4	3/4	5-5/8	11-5/8	27-3/8	33-3/8
	12-3/4	1	5-5/8	11-5/8	27-7/8	33-7/8
14	14	1/2	7	14	30-1/4	37-1/4
	14	3/4	7	14	30-3/4	37-3/4
	14	1	7	14	31-1/4	38-1/4
16	16	1/2	8	16	34-3/8	42-3/8
	16	3/4	8	16	34-7/8	42-7/8
	16	1	8	16	35-3/8	43-3/8
18	18	1/2	9	18	38-1/2	47-1/2
	18	3/4	9	18	39	48
	18	1	9	18	39-1/2	48-1/2
20	20	1/2	10	20	42-5/8	52-5/8
	20	3/4	10	20	43-1/8	53-1/8
	20	1	10	20	43-5/8	53-5/8
24	24	1/2	12	24	51	63
	24	3/4	12	24	51-1/2	63-1/2
	24	1	12	24	52	64

*For jobsite application sizing. Not intended for shop fabrication.

Please note: For installing self adhering SA Armaflex sheets and rolls, refer to p.19.

Installation:

4.c. Armaflex sheet on 90° elbows

1. Check the type ell (long or short radius) and size.
2. Take throat measurement from chart (R1). Swing an arc from one corner of the Armaflex sheet, using this measurement. Take half circumference plus throat measurement from chart (R2). Using the same corner of the sheet from which the arc R1 was drawn, now swing an arc, using the measurement R2.
3. Cut out on arcs R1 and R2, and use as a pattern for the second half of the elbow cover. Adhere outer arcs of the two halves with Armaflex 520 or 520 BLV Adhesive. As arcs are adhered, the cover will “dish” upward. After seam is squeezed together on one side, “dish” the cover the opposite direction, and squeeze the other side of seam.

4. Put cover around elbow fitting, and adhere inner arcs.
5. Trim ends of fitting cover square to meet the straight pipe insulation. Place metal band or metal strap around fitting cover, and scribe a straight line. Then trim with a sharp knife.

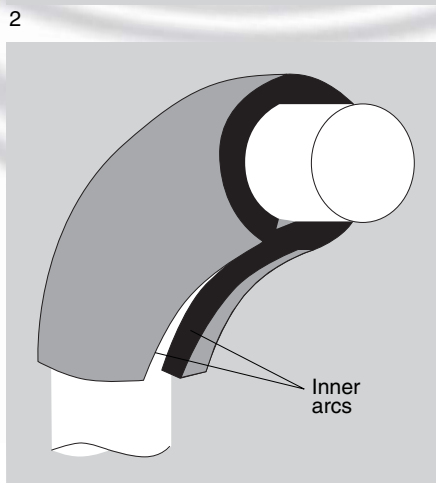
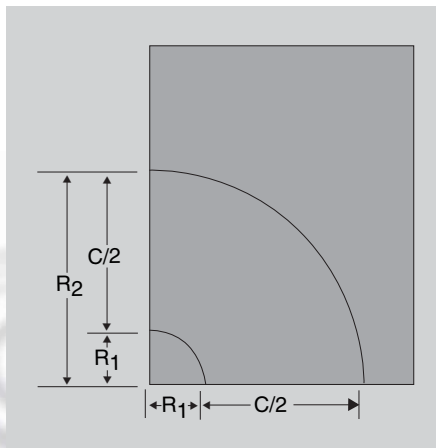

4

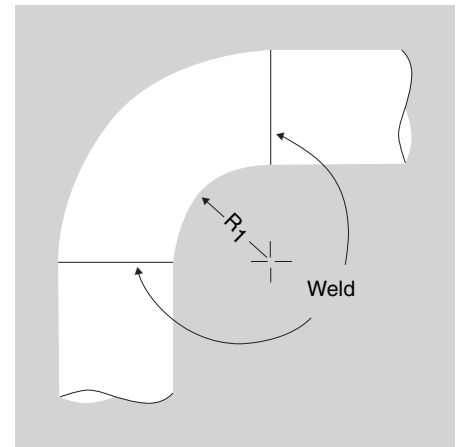

1

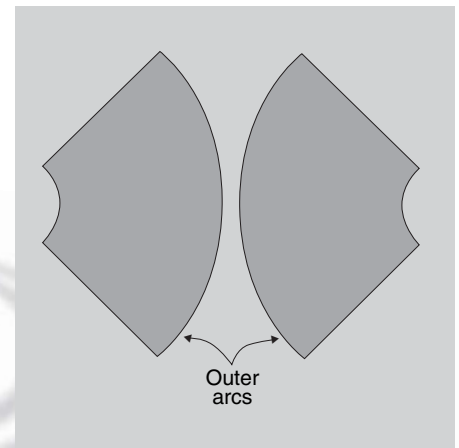

3

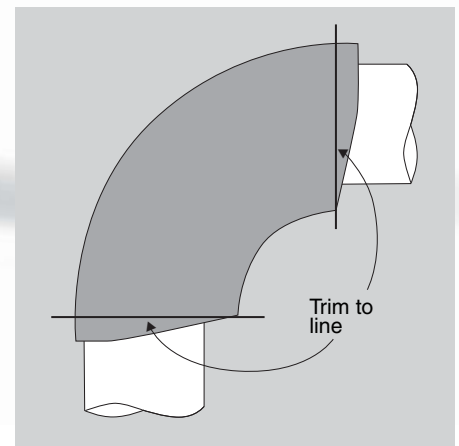

5

Installation:

4.d. Armaflex sheet on flanged valve fitting covers

These instructions are meant to serve as a guide for insulating flanged valves with Armaflex. Because of the variety in shape and design of flanged valves, some modifications to these instructions may be necessary.

1. Cut Armaflex donuts the same diameter as the flanges, and install at pipe/flange and valve stem areas.

2. Use scrap strips of Armaflex Sheet to build the body of the valve out until it is the same dimension as the OD of the flanges. Adhere the Armaflex strips directly to the valve body, using 520 or 520 BLV Adhesive.

3. Use a strip of Armaflex Sheet to wrap around the flange to measure the circumference or length of the Armaflex Sheet needed for the valve body.

4. Cut Armaflex Sheet for the valve body.

A. This length is determined as shown in Figure 3.

B. This length is obtained by measuring the distance between the outer edges of the Armaflex donuts which are located at the flanges.

C. To fit around the valve throat, a semicircle is cut from each end of the Armaflex Sheet. The diameter of semicircle is determined by the measure-

ment across the throat of the valve at a point under the flange where the stem enters.

5. The Armaflex Sheet, cut out as shown in Figure 4, is installed around the valve body and the joint adhered with 520 Adhesive.

At this time, the Armaflex donuts at the ends of the fitting should be sealed to the fitting body insulation with 520 Adhesive.

This is accomplished by running the adhesive brush between the outer circumference of the Armaflex donut and the inside of the ends of the body insulation (a wet joint).

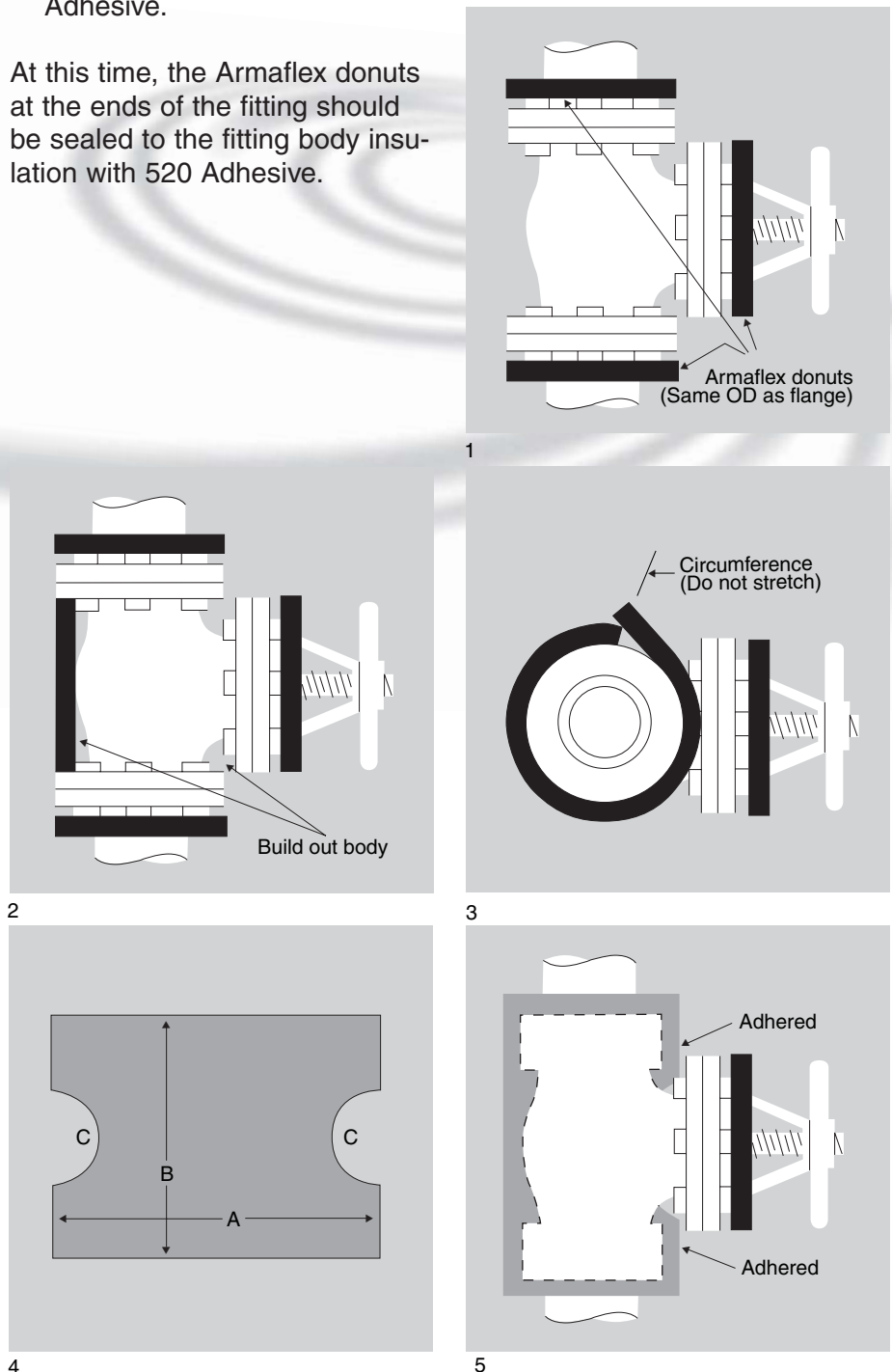

Installation:

- The last piece of insulation needed will insulate the bonnet area. This is shown in Figure 6 and is made as shown in

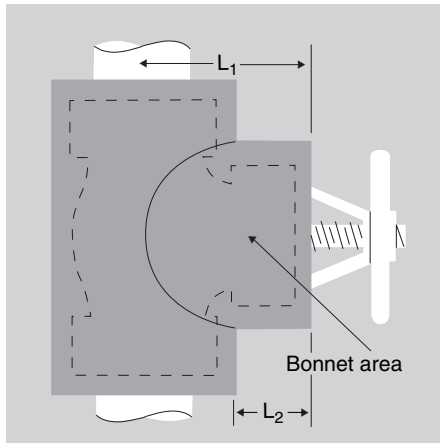

6

Figure 6A. The measurements for Figure 6A are determined as follows:

- C—The overall length is determined by wrapping a strip of Armaflex Sheet around the bonnet flange (do not stretch) and marking where the ends meet.
- L1—This distance is obtained by measuring from the outer surface of the Armaflex donut to the approximate middle of the valve body insulation.
- L2—This distance is obtained by measuring from the outer surface of the Armaflex donut to the closest surface of the valve body insulation.
- Y—is the difference between L1 and L2.

The bonnet insulation of Armaflex Sheet is cut to the size of $C \times L1$. This is then marked to show L2 and marked in quarters as shown in Figure 6A. Next the scalloped edge of the insulation is determined by swinging an arc from each point marked + in Figure 6A. The radius of the arc is equal to Y. These arcs are connected with straight lines to give a smooth scalloped edge (see Figure 6B). The scalloped edge of the insulation must be undercut (beveled) to correctly meet the body insulation.

The bonnet insulation may now be installed using 520 or 520 BLV Adhesive to bond the two ends, to adhere the bonnet insulation to the body insulation and to adhere the bonnet insulation around the Armaflex donut. This should complete the flange valve fitting.

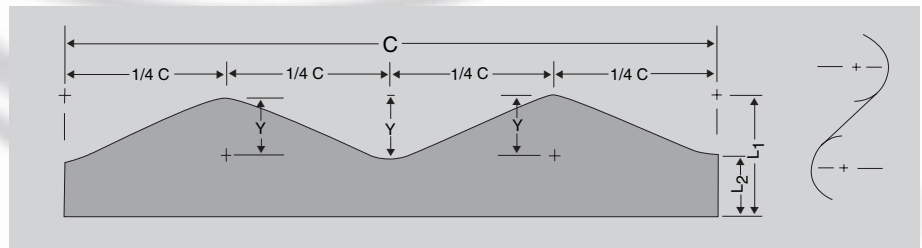

6A

6B

Installation:

Please note: For installing self adhering SA Armaflex sheets and rolls, refer to p.19.

Armaflex sheet on metal ductwork

The preferred method for square and rectangular ducts is to cut and fit the sheets, using full coverage of Armaflex 520 or 520 BLV Adhesive to adhere the insulation.

1. **Measure**—Sheets should be sized with the following application sequence in mind. Cut the bottom piece first, making it the same width as the duct. Then cut the two side pieces, so that they extend down over the edges of the bottom insulation; keep top edges flush with the top of the duct. The top insulation should be sized so that it extends over the side insulations. The fabrication must be done at the job site, at the same ambient conditions as the application.

2. **Cut**—A sharp knife and a straightedge are the only tools required. Armaflex Sheet cuts cleanly.

3. **Apply Adhesive**—First brush- or roller-coat 520 or 520 BLV Adhesive on the metal duct surface. Then coat the back side of the Armaflex Sheet, leaving a 1/2"-wide uncoated border at butt-edge seams. Allow the adhesive to dry to the touch but still tacky under slight pressure before joining surfaces.

4. **Bond**—Position the sheet so that it overlaps the edges of previously installed sheet or sheets by 1/8". Hold the sheet

in this position, and spot-adhere it in the center. Compress the butt edges into place for a tight joint with adjoining sheets. Then bond the remainder of the sheet by pressing it firmly into place. A small hand roller will help apply pressure.

5. **Adhere Joints**—Spread the joint, and with a small brush, apply 520 or 520 BLV Adhesive to both butt edges. Do not flood joint with adhesive. Align carefully for good appearance, and apply pressure to joint.

6. **Standing Seams**—These can be insulated with strips of Armaflex Sheet, generally cut from scrap.

7. **Alternate Method**—Standing seams can also be insulated with half sections of Armaflex Pipe Insulation, corresponding in thickness to the sheet used on the duct surface. Ends should be miter-cut to insure tight fit when bonded.

8. **Apply WB Armaflex Finish**—Two coats of WB Armaflex Finish, a white water-based latex enamel coating, are all that is required to provide a protective finish for outdoor installations. WB Armaflex Finish can be brush- or roller-applied.



1



2

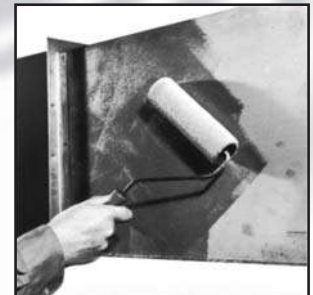

3



4



5



6



7



8

Please note: For installing self adhering SA Armaflex sheets and rolls, refer to p.19.

Installation:

Flexible ArmaTuff Plus, ArmaTuff White or ArmaTuff Silver can be used for all exterior applications. They are practical also for use on exterior ducts, tanks, vessels, large pipes and fittings. The material provides a durable, tough and maintenance-free surface. The material is resistant to UV, ozone, acid rain and most industrial pollutants. No painting is required.

The recommended temperature usage range for ArmaTuff is -70°F to 180°F (-57°C to 82°C). The closed cell structure of ArmaTuff insulation effectively retards the flow of water vapor, and it is considered a low transmittance vapor retarder. ArmaTuff does not require additional vapor retarder. The white surface reflects heat to reduce energy load.

ArmaTuff is installed using Armaflex 520 or 520 BLV adhesive or with pre-applied pressure sensitive adhesive (PSA). For application to large, flat or curved metal surfaces such as ducts, vessels, very large pipes or tanks, full Armaflex 520 or 520 BLV adhesive coverage or product with PSA is used. The seams must be installed in compression and sealed with Armaflex 520 or 520 BLV Adhesive. Cover the seam with 4" and exposed edges with 4" or 6" ArmaTuff Seal Tape. Armaflex 520 or 520 BLV adhesive is a contact adhesive: therefore it must be applied to both surfaces, allowed to get tacky, and the surfaces are joined with pressure.

ArmaTuff is designed for installation in above ground applications. Armaflex insulation products must be installed according to Installation of Armaflex Insulations brochure. Proper installation is required to assure Armaflex insulation performance.

Applying Non-Self Adhering ArmaTuff Sheets



1. Always prepare surface by cleaning with denatured alcohol.



4. Position carefully and apply ArmaTuff. Contact adhesive bonds instantly.



2. Insulate sides first. Apply thin, uniform coat of Armaflex 520 or 520 BLV Adhesive.



5. Apply ArmaTuff to top surface, overlapping the side pieces.



3. Roll thin coat of 520 or 520 BLV Adhesive to insulation.

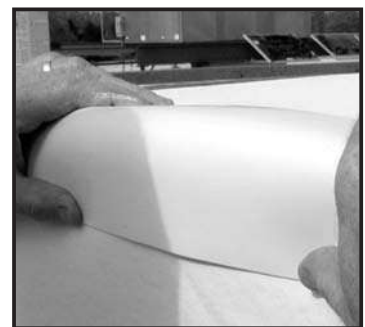

6. Seal and protect exposed edges and seams with ArmaTuff Seal Tape.

Installation:

Pipe hanger locations

At pipe hanger locations where the insulation must resist compression, supporting devices must be used in combination with metal hanger shields.

Armafix Insulation Pipe Hangers

Armafix IPH (Insulation Pipe Hangers) and NPH (Nonhalogen Insulation Pipe Hangers) provide fast, reliable support for insulated pipes, an innovative alternative to traditional block and dowel methods. The pre-insulated hangers ensure optimum load bearing, protect against thickness compression, and prevent condensation gaps that could otherwise compromise system integrity. To minimize the movement of Armaflex, it is recommended that a pair of non-skid pads be adhered to the clamps. In addition, to prevent loosening of the clamps, use of an anti-vibratory fastener, such as a nylon locking nut is recommended.

Armafix features a self-adhesive closure and an exclusive foam-to-foam bond. The insulated pipe hanger is adhered to Armaflex insulations using Armaflex 520 or 520 BLV Adhesive.

If the application is for clevis or saddle type of pipe hangers it is recommended that Armaflex Tape be wrapped around the Armafix prior to placing in the clevis or saddle hanger.

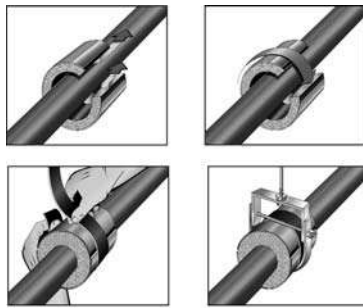

Application with insulation



Clamp (Friction Fit)

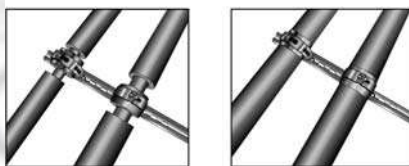

Traditional method

Although timesaving Armafix IPH or NPH is recommended, you can use traditional supporting devices such as short lengths of wood dowels or wood blocks, which are the same thicknesses as the Armaflex. These supporting devices rest on the metal shield that is installed between the insulation surface and the pipe hanger.

Short wood dowels, used singly or in multiples, may be used to support small-size pipes (see Figure 1). Larger-size pipes will require woodblocks approximately 1" x 3" or 1-1/2" x 4" by the Armaflex thickness, singly or in multiples. It is always best to curve the woodblock surfaces to match the curve of the pipe and the curve of the metal shield. The holes cut into the Armaflex

to receive the supporting devices are to be undersized so the supporting devices fit tightly. Coat the supporting device with 520 or 520 BLV Adhesive, and insert into the hole in the Armaflex while the adhesive is still wet; then coat the outer surface with adhesive as a vapor seal. To eliminate the possibility of large or heavy pipes from teetering on the woodblocks, it is recommended that 3/4"- or 1"-diameter wood dowels be placed at 4 o'clock and 8 o'clock positions with each woodblock (see Figure 2).

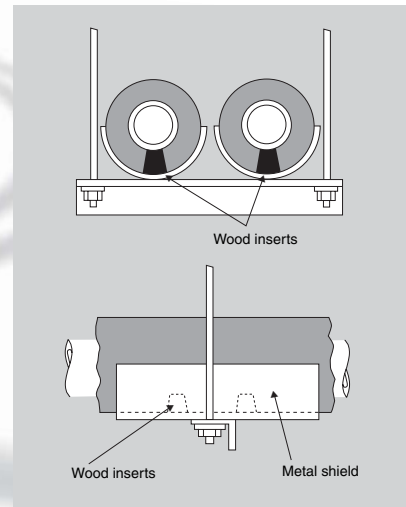

FIG. 1

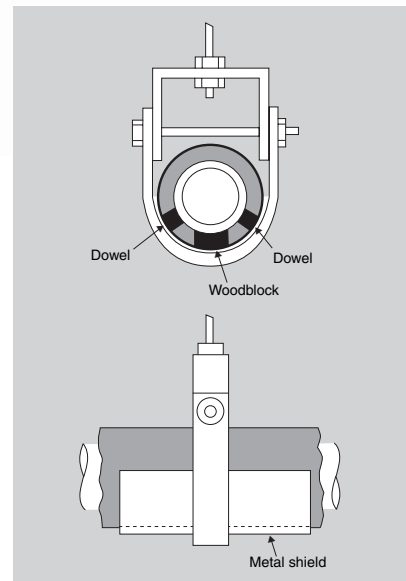
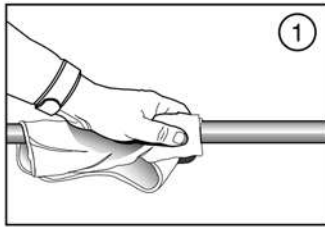

FIG. 2

Installation:

AP ARMAFLEX SS INSTALLATION INSTRUCTIONS



1 Make sure pipe is clean and dry. Wipe with a clean rag to remove any contaminants or moisture

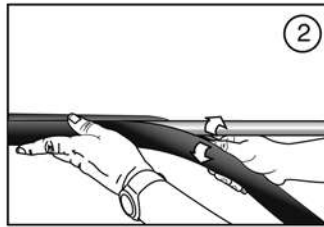

2 Snap the tubing over the pipe with a gentle twisting motion.

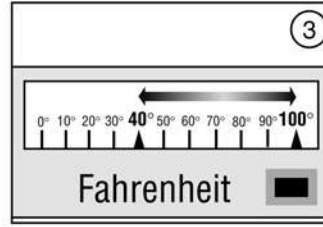

3 The temperature of the air and of the insulation should be between 40°F (4°C) and 100°F (38°C) at the time of installation

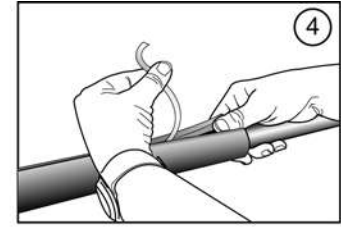

4 PINCH and gently LIFT the protective release strips from the adhesive surface.

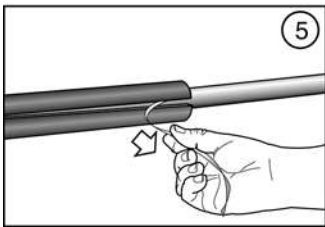

5 Peel the protective release strips from the adhesive surface in 8" and 12" intervals. The protective release strips can be removed by gently pulling at an angle.

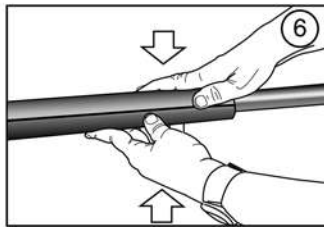

6 Seal the 8" and 12" intervals by applying **firm pressure** along the joint.

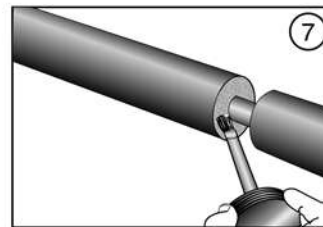

7 Secure butt ends by aligning longitudinal seams of the tube. Apply Armaflex 520 or 520 BLV Adhesive to both sides of the butt ends. Apply firm pressure after the adhesive has been allowed to become tacky.

NOTE: To insure clean joints—Remove protective release strips in 12" increments AFTER insulation is snapped over pipe.

INSTALLATION OF SELF-ADHERING SHEET AND ROLL INSULATION

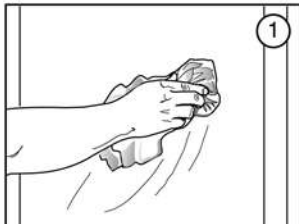

1 Surface to be covered must be clean and free of any loose materials such as rust. A) Prepare surface by cleaning with rubbing or denatured alcohol and a clean cloth. B) Remove rust and prepare surface with primer and paint

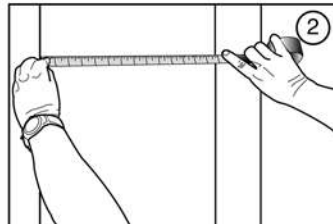

2 Measure

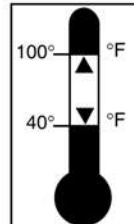

3 The temperature of the air and of the insulation should be between 40°F (4°C) and 100°F (38°C) at the time of installation.

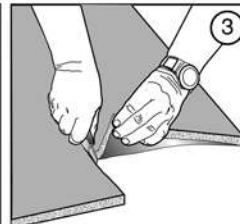

4 Cut with a sharp knife.

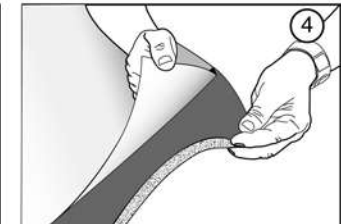

5 Peel back enough release liner to start

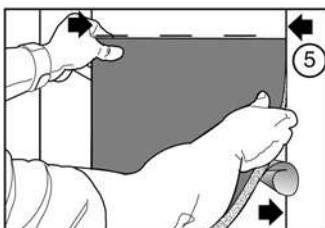

6 Square off sheet along an edge or corner.

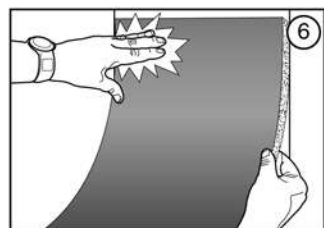

7 Press the sheet to the surface taking care not to trap any air.

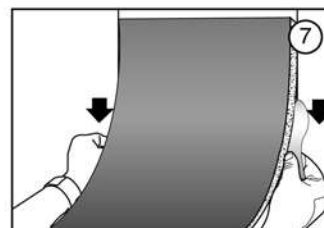

8 Reach behind the Armaflex sheet and peel liner back while pressing the sheet to the surface. Remove the entire liner piece.

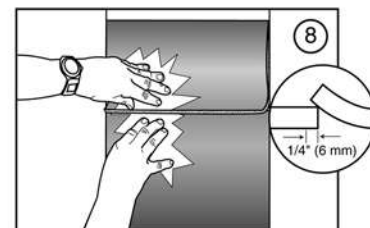

9 Press firmly. Butt joints require the use of compression joints to prevent the possible opening of seams. Apply Armacell 520 or 520 BLV Adhesive to compression joints.

INSTALLATION MANUAL

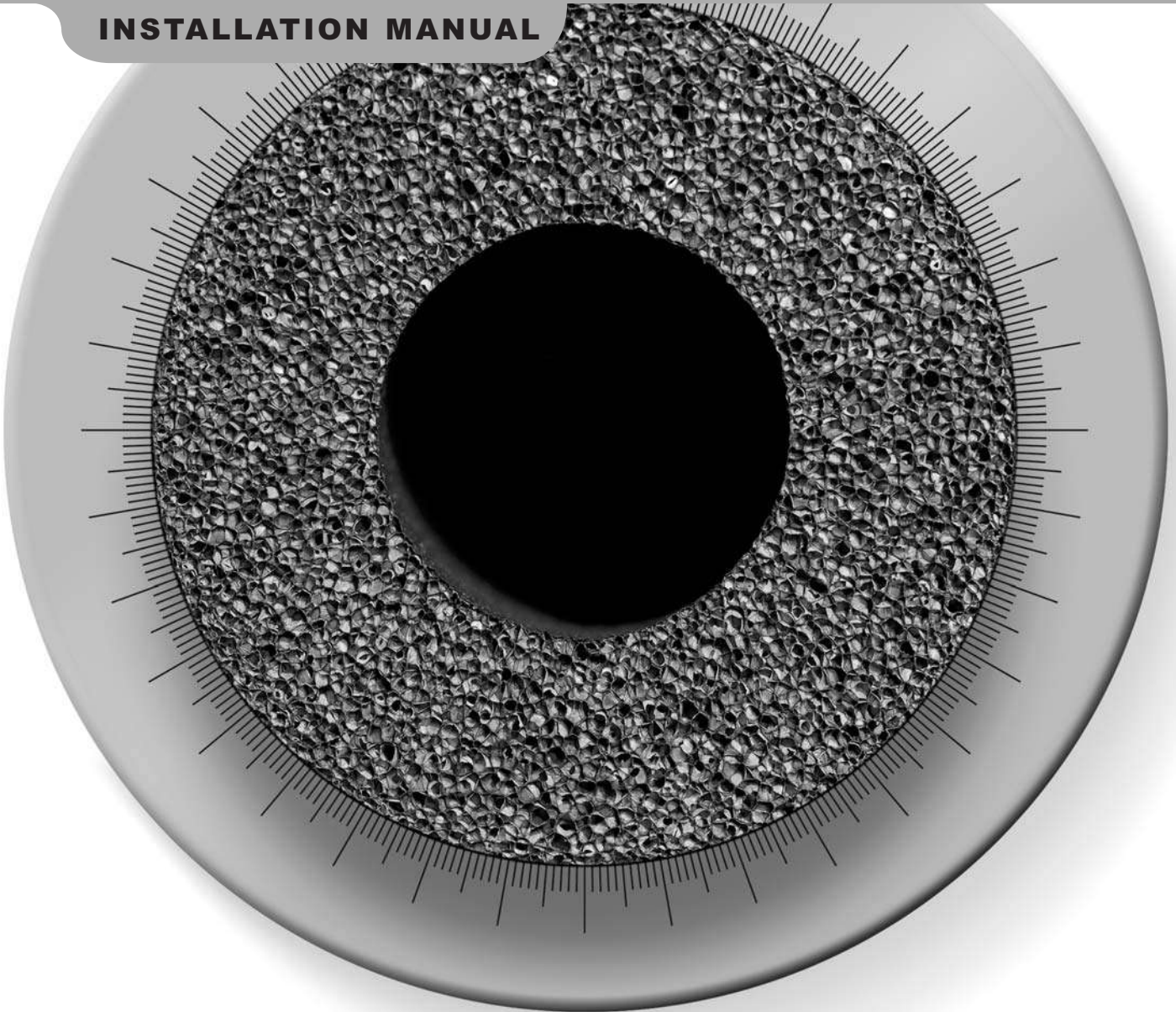

Armacell provides this information as a technical service. To the extent the information is derived from sources other than Armacell, Armacell is substantially, if not wholly, relying upon the other source(s) to provide accurate information. Information provided as a result of Armacell's own technical analysis and testing is accurate to the extent of our knowledge and ability, as of date of printing, using effective standardized methods and procedures. Each user of these products, or information, should perform their own tests to determine the safety, fitness and suitability of the products, or combination of products, for any foreseeable purposes, applications and uses by the user and by any third party to which the user may convey the products. Since Armacell cannot control the end use of this product, Armacell does not guarantee that the user will obtain the same results as published in this document. The data and information are provided as a technical service and are subject to change without notice.



ARMACELL LLC
7600 Oakwood Street Extension • P.O. Box 1038
Mebane, NC 27302
TEL. 919 304-3846 • FAX 919 304-3847
E-MAIL info.us@armacell.com
INTERNET www.armacell.com

For any updates on this document please refer to our website.

000	005	01	06	NA	NA
-----	-----	----	----	----	----

© 2006 Armacell LLC
Printed in United States of America